

6.2 Kirchoff's Laws

1. Determine I_1

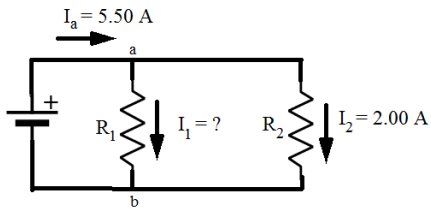

2. Determine I_b, I_3

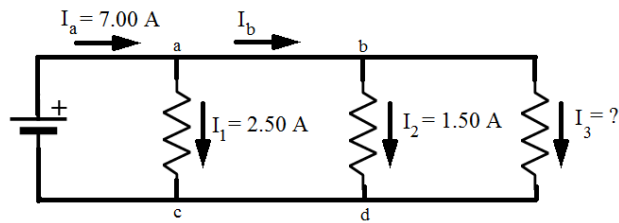

3. Determine I_x

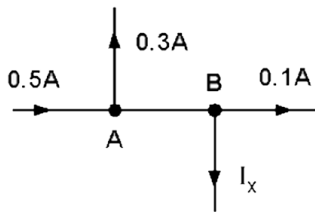

4. Determine I_1

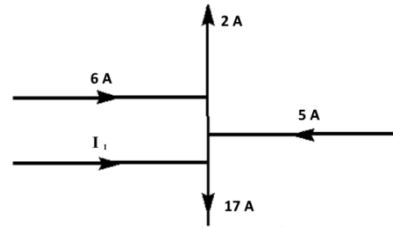

5. Determine I_1, I_2, I_3, I_4, I_5

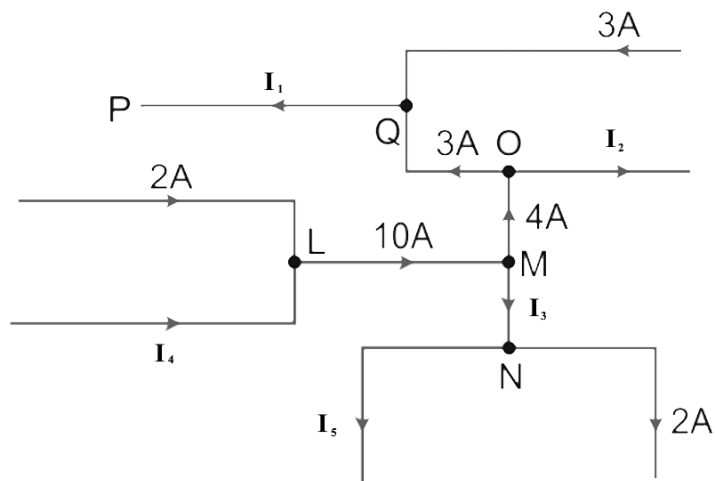

6. Determine V

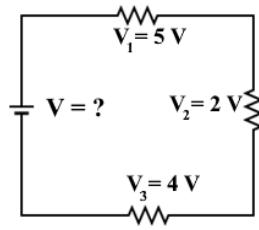

7. Determine V_1, V_2

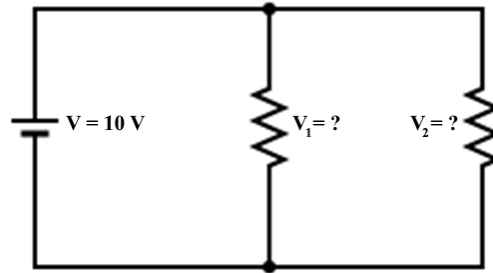

8. Determine V, V_1, V_2

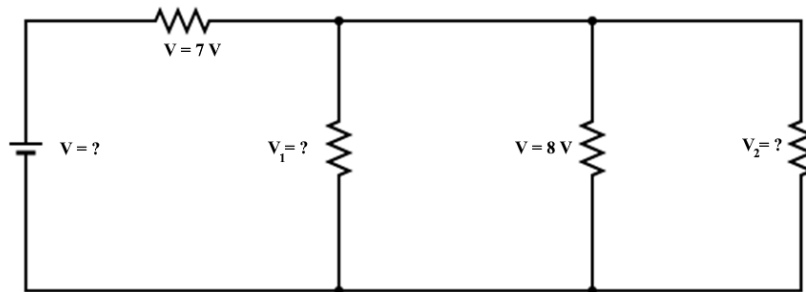

9. Determine V_1, V_2, V_3

